

Manufacturer's Declaration of Conformity

This product has been manufactured in accordance with the harmonized European standards, following the provisions of the below stated directives:

	93/42/EEC as amended by 2007/47/EC Medical Device Directive
--	---

Please see separate document showing on sticker of device for above CE marking.

Authorized EU Representative:



Wellkang Ltd
Suite B, 29 Harley Street
LONDON, W1G 9QR, U.K.

Manufactured by:

 **Charder Electronic Co., Ltd.**
No.103, Guozhong Rd., Dali Dist.,
Taichung City 412, Taiwan (R.O.C.)

FDA no.: D072478



charder[®]

**HM200P
PortStad
Height Measurement**

TABLE OF CONTENTS

PREFACE.....	2
CLEANING.....	2
MAINTENANCE	2
SAFETY INSTRUCTIONS	2
WARRANTY.....	3
EXPLANATION OF THE GRAPHIC SYMBOLS.....	4
UNPACKING HM200P	6
ASSEMBLY INSTRUCTION.....	7
DISASSEMBLING HM200P.....	8
STEP TO ACCURATE MEASUREMENT	9
SPECIFICATION	10
INSTRUCTION OF USE HEAD STOPPER.....	10

SPECIFICATION

Measuring range: 14 ~ 205cm

Graduations: 1mm / Accuracy: ± 10 mm

Dimensions (WxHxL): 35 x 40 x 243cm

Weight: 1.9kg

Temperature range: 5°C up to 35°C

INSTRUCTION OF USE HEAD STOPPER

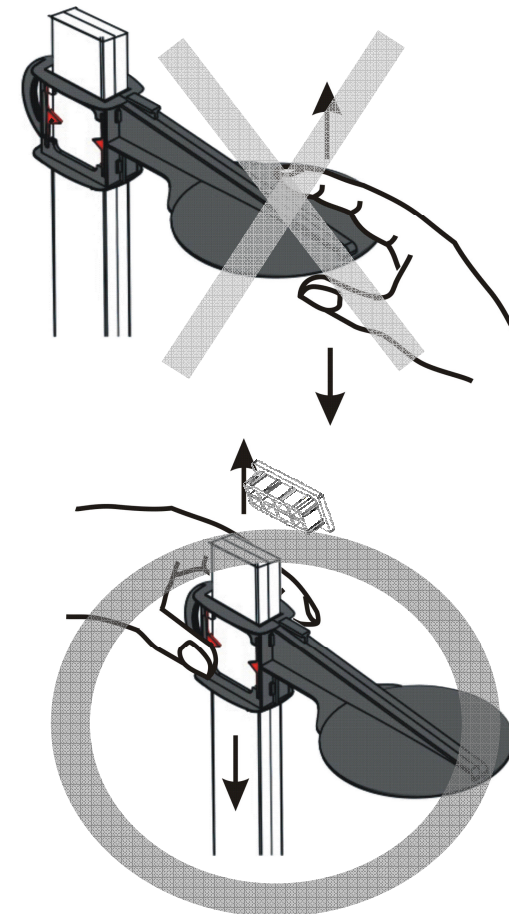

STEP TO ACCURATE MEASUREMENT

*The best measuring time is in the morning at the same time.

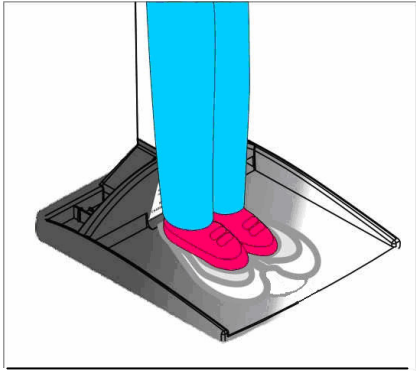

1. Stand up straight with foot inside footprint mark.

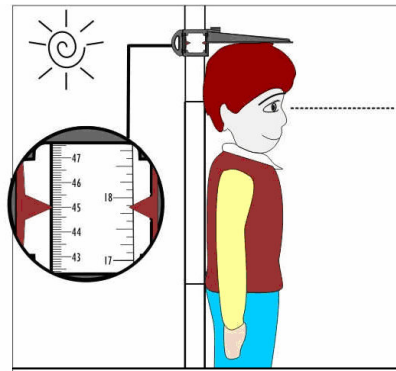

2. Have patient's back slightly touches the rod.

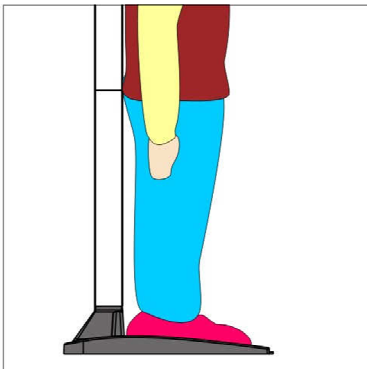

3. Move head stopper down to the top of head.



4. Height is ready to be taken.

PREFACE

Thank you for choosing CHARDER MEDICAL product. All features of this product were designed to state of the art and are optimized for simple and straightforward use. If you have any queries or experience any problems not addressed in the operating instructions, please contact your CHARDER MEDICAL service partner, or visit us on the Internet at www.chardermmedical.com

CLEANING

To clean the measuring rod as required using cleaning agent or disinfectant agent.

MAINTENANCE

The device does not require any routine maintenance. Daily wipe with water or cleaning agent to keep cleaning and disinfected is recommended.

SAFETY INSTRUCTIONS

Proper use

This height measuring rod is used to determine the height of persons while standing upright, or of lying babies, according to its model, in medical treatment localities. This height measuring rod is suitable to detect, prevent and survey diseases.

Ensure that the height measuring rod may only come into contact only with uninjured skin.

Improper Use

The structure of the height measuring rod may not be modified. This may result in incorrect measuring results, safety-related defects as well as destruction.

The height measuring rod may only be used according to the described conditions.

Safety Instructions

Observe operating instructions.

Please use no other than the supplied fixtures for mounting.

During assembling, ensure that screws are tightened properly and that the height measuring rod has been assembled correctly.

To prevent risk of injury, ensure that the head stop is returned to folded-in position after each use.

The body height measuring emits only reliable values, when the back and the head are straightly aligned, nevertheless the body height of a person may change about some cm during a day.

Never leave a baby on the surface unsupervised

When sliding the rod, ensure that baby is safely on the measuring area.

WARRANTY

A two-year warranty from date of delivery applies to defects attributable to poor materials or workmanship. Defects, which come under warranty, will be made good for the customer at no charge on production of the receipt. No further claims can be entertained. The costs of transport in both directions will be borne by the customer should the equipment be located anywhere other than the customer's premises.

In the event of transport damage, claims under warranty can be honored only if the complete original packaging was used for any transport and the device secured and attached in that packaging just as it was when originally packed. All the packaging should therefore be retained.

A claim under warranty will not be honored if the equipment is opened by persons not expressly authorized by Charder to do so.

We would ask our customers abroad to contact their local sales agent in the event of a warranty matter.

PLEASE VISIT WWW.CHARDERMEDICAL.COM FOR MORE INFORMATION.

DISASSEMBLING HM200P

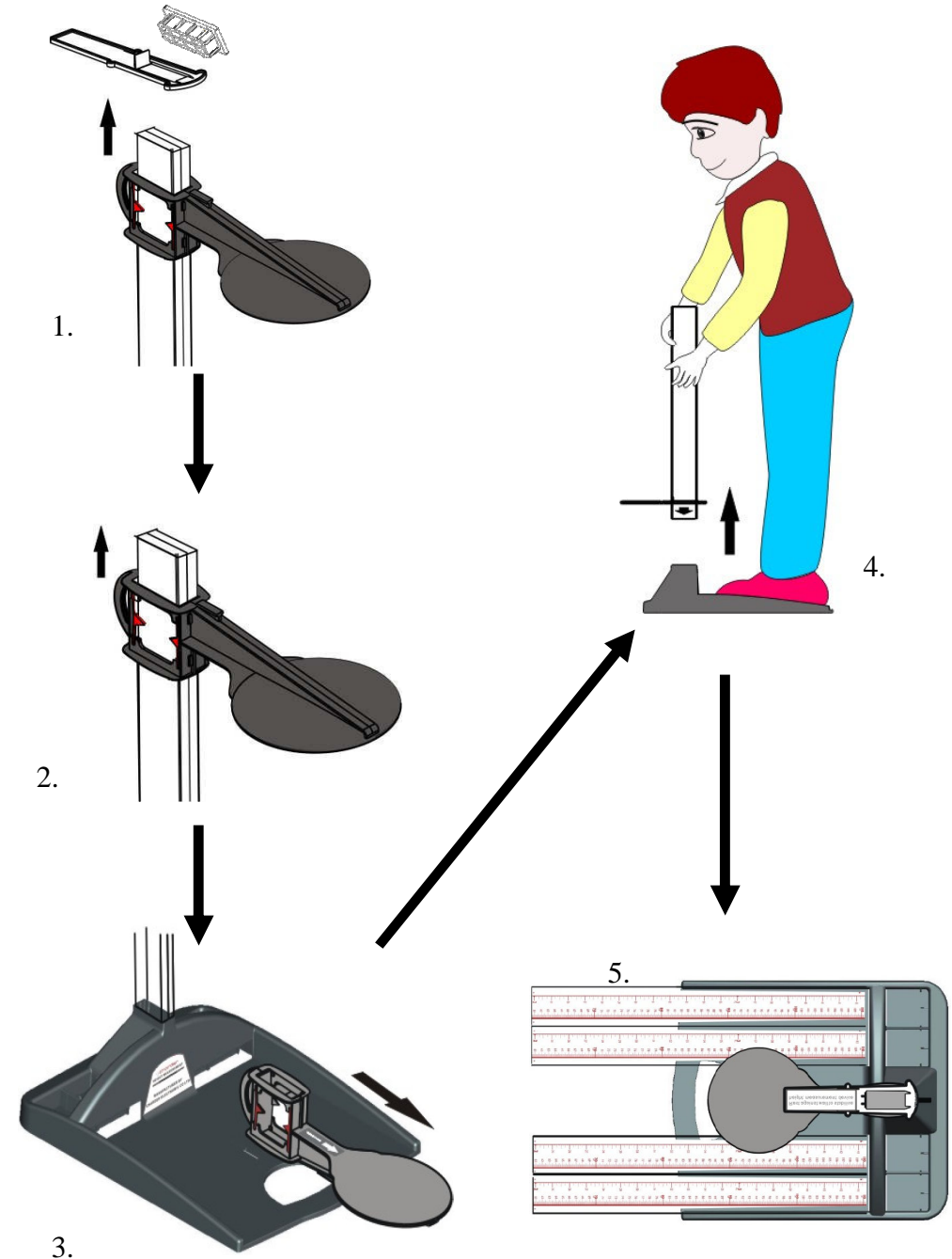

ASSEMBLY INSTRUCTION

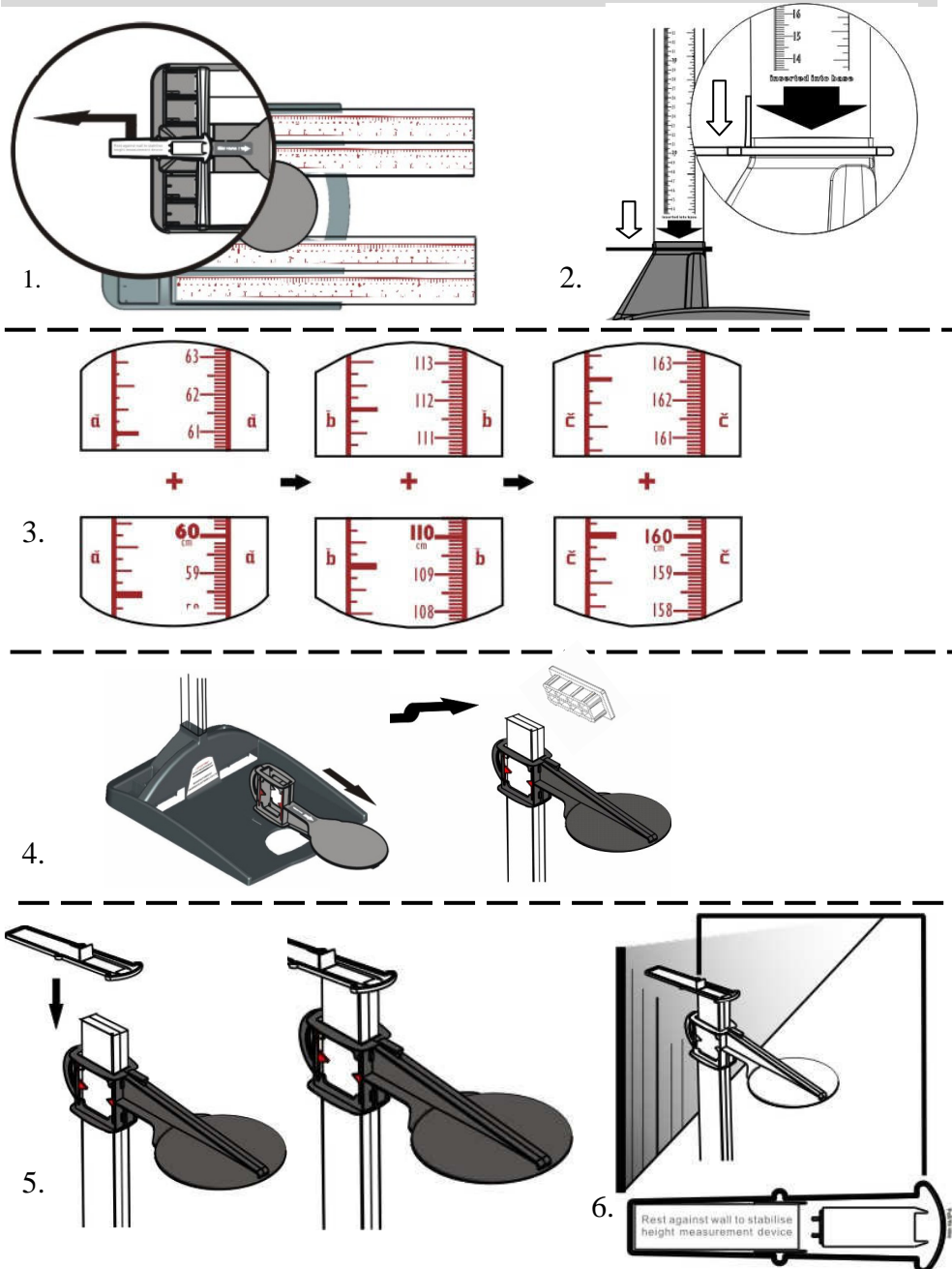

Rest against wall to stabilize HM200P

EXPLANATION OF THE GRAPHIC SYMBOLS

SN-T13000001

Designation of the serial number of every device, applied at the device.

(Number as an example)

“Please note the accompanying documents”
or “Observe operating instructions”



Identification of manufacturer of medical product including address



Charder Electronic Co., Ltd.
No.103, Guozhong Rd., Dali Dist.,
Taichung City 412, Taiwan (R.O.C.)

“Electro-medical appliance”
with attachment for type B



Dispose of old appliances
separately from your household
waste !!!
Instead, take them to communal
collection points.



Carefully read this operation manual
before setup and commissioning,
even if you are already familiar with
Charder scales.



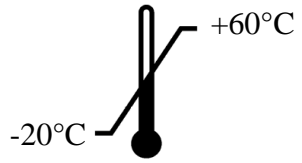

Transport and storage temperature limit indicating the upper and the lower limit
(Transport and storage temperature on packaging)

UNPACKING HM200P

No.	Item	Quantity
1.	Support plate	2
2.	Head Stopper	1
3.	Base Platform	1
4.	Height Rod	4

