



Lift Scale

USER MANUAL MHS2510I/MHS2610I

















Please keep the instruction manual at hand and follow instruction for use.

CONTENTS

Explanation of Graphic Symbols on Label/Packaging ...	3
I. Safety Notes	6
A. General Information	6
B. EMC Guidance and Manufacturer's Declaration	9
II. Installation.....	14
A. Safety Warning	14
B. Inserting Batteries	20
III. Indicator and Key Functions	21
A. Device indicator (OIML model).....	21
B. Key Function	22
IV. Using Device	23
A. Basic Operation	23
B. Hold	23
C. BMI(3-key model)	24
D. Tare	24
V. DeviceSetup	25
VI. Troubleshooting.....	28
Self-inspection.....	28
Error Messages.....	29
VII. Product Specifications.....	30
A. Device Information.....	30
B. Technical Data for Joints	31
VIII. Declaration of Conformity.....	32

Explanation of Graphic Symbols on Label/Packaging

Text/Symbol	Meaning
	Caution, consult accompanying documents before use
	Separate collection for waste of electrical and electronic equipment, in accordance with Directive 2002/96/EC. Do not dispose of device with everyday waste
	Name and address of device manufacturer, and year/country of manufacture
	Carefully read user manual before installation and usage, and follow instructions for use.
	Medical electrical device, Type B applied part
	Medical electrical device, Type BF applied part
	Device catalogue number / model number
	Name and address of authorized representative in the European Union
	Device is a medical device. Text indicates device category type
	Manufacturer's batch or lot number for device
	Device's serial number
	Device's Unique Device Identifier
	Verification Scale Interval. Value expressed in units of mass. Used to classification and verification of an instrument.
	Device conforms to (EU) 2017/745 Regulation on Medical Devices. Four-digit number is identifier for medical device Notified Body

Device complies with EC directives (verified models only)

CE **M 20** 0122 **M**: Conformity label in compliance with Directive 2014/31/EU for non-automatic weighing instruments
20: Year in which conformity verification was performed and the CE label was applied. (ex: 16=2016)
0122: Identifier for metrology Notified Body



Device is a Class III scale in compliance with Directive 2014/31/EU (verified models only)



Name and address of entity importing device (if applicable)



Name and address of entity responsible for translating Information For Use (if applicable)

CON.

Event counter confirming how many times device has been calibrated (if applicable)



Device conforms to Taiwan National Communications Commission(NCC) approval



Device conforms to U.S. Federal Communications Commission regulations

UK **M 20** 8506 Device complies with UK non-automatic weighing instruments regulations 2016 (verified models only)
M: Conformity label in compliance with Non-automatic Weighing instruments Regulations 2016
20: Year in which conformity verification was performed and the UKCA label was applied. (ex: 20=2020)
8506: Identifier for metrology approved body



Device complies with all UK applicable product legislation



Device's polarity of power.

"In case of differences, icon on device itself takes precedence"

Copyright Notice
Charder Electronic Co., Ltd.

No.103, Guozhong Rd., Dali Dist., Taichung City 41262 Taiwan

Tel: +886-4-2406 3766

Fax: +886-4-2406 5612

Website: www.chardermedical.com

E-mail: info_cec@charder.com.tw

Copyright© Charder Electronic Co., Ltd. All rights reserved.
This user manual is protected by international copyright law. All content is licensed, and usage is subject to written authorization from Charder Electronic Co., Ltd. (hereinafter Charder) Charder is not liable for any damage caused by a failure to adhere to requirements stated in this manual. Charder reserves the right to correct misprints in the manual without prior notice, and modify the exterior of the device for quality purposes without customer consent.



Charder Electronic Co., Ltd.
No. 103, Guozhong Rd., Dali Dist.,
Taichung City, 41262 Taiwan

I. Safety Notes

A. General Information

Thank you for choosing this Charder Medical device. It is designed to be easy and straightforward to operate, but if you encounter any problems not addressed in this manual, please contact your local Charder service partner.

Before beginning operation of the device, please read this user manual carefully, and keep it in a safe place for reference. It contains important instructions regarding installation, proper usage, and maintenance.

Intended Purpose

This medical device is designed to be used in accordance with national regulations, to measure weight within specifications, for weight-related usage by professionals.

Patient sits in sling attached to device, which is attached to lift system. Lift system suspends patient from ground, as device measures weight.

Clinical Benefit

Measurement results can be used by professionals to diagnose (and monitor) weight-related issues.

Intended medical indications/contraindications

Measurement: patient's body weight. No known contraindications to measurement of body weight.

Intended patient profile

- (a) Age: no restrictions
- (b) Weight: no restrictions within device weight capacity (note: device is used together with lift system; as such, lift system maximum capacity is also a consideration. If it is lower than device capacity, the lower capacity should be used as upper limit)
- (c) Patient Conditions: require measurement of body weight. Likely to be sitting in sling attached to lift system

Intended user profile

- (a) At least 20 years old
- (b) Minimum knowledge:
 - To be able to read at a high-school level and understand Arabic numerals (e.g. 1, 2, 3, 4...)
 - Basic hygiene knowledge
 - Trained in device's operation
 - Read the instruction manual
- (c) Language
 - Able to read the language of instruction manual and on-screen instructions
- (d) Qualifications
 - No special certifications or qualifications required
 - Able to help support patient in lift process

Residual risk evaluation

- (a) All foreseeable risks have been evaluated and considered acceptable. Generally speaking, the most likely risk caused by incorrect usage of the device is less accurate measurement (or inability to use device to acquire measurement), which does not pose imminent physical risk to patient or user.
- (b) Benefit-risk ratio is considered acceptable. Lift scales are an important option for measuring patients. Usage of device is unlikely to result in harm to user or patient.

General Handling

- Ensure all parts are properly locked and tightened before operating the device.
- Measurement accuracy requires the subject's feet, back, and head to be straightly aligned. Please note that height can vary throughout the day
- **CAUTION:** Do not use next to equipment that may cause electromagnetic or other types of interference.

Safety Instructions

Before putting device into use, please read this user manual carefully. It contains important instructions for installation, usage, and maintenance of device.

The manufacturer shall not be liable for damages caused by failure to heed the following instructions:

- The device has an expected service life of 5 years when correctly handled, serviced, and periodically inspected in accordance with manufacturer's instructions.
- Improper installation will render the warranty null and void.
- Observe permissible ambient temperatures for use

Cleaning

- Device surface should be cleaned using alcohol-based wipes.

Maintenance

- Please contact your local Charder distributor for regular maintenance and calibration, regular checking of accuracy is recommended; frequency to be determined by level of use and state of device.

Warranty/Liability

- The period of warranty shall be eighteen(18) months, beginning on the date of purchase. Please retain your receipt as proof of purchase.
- No responsibility shall be accepted for damage caused through any of the following reasons: unsuitable or improper storage or use, incorrect installation or commissioning by the owner or third parties, natural wear and tear, changes or modifications, incorrect or negligent handling, chemical, electrochemical, or electrical interference, unless damage is attributable to negligence on the part of Charder.
- This device does not contain any user-maintained parts. All maintenance, technical inspections, and repairs should be conducted by an authorized Charder service partner, using original Charder accessories and spare parts. Charder is not liable for any damages arising from improper maintenance or usage. Dismantlement of the device will void the warranty.

Incident Reporting

Any serious incident that has occurred in relation to the device should be reported to the manufacturer, EU representative (if device is used in EU member state), and competent authority of user/subject's member state.

B. EMC Guidance and Manufacturer's Declaration

Guidance and manufacturer's declaration-electromagnetic emissions		
The product is intended for use in the electromagnetic environment specified below. The customer or the user of the product should assure that it is used in such an environment.		
Emission test	Compliance	Electromagnetic
RFemissions CISPR 11	Group 1	The product uses RF energy only for its internal function. Therefore, its RF emissions are very low and are not likely to cause any interference in nearby electronic equipment.
RF emissions CISPR 11	Class A	The product is suitable for use in all establishments other than domestic and those directly connected to a low voltage power supply network which supplies buildings used for domestic purposes.

Guidance and manufacturer's declaration-electromagnetic immunity

The product is intended for use in the electromagnetic environment specified below. The customer or the user of the product should assure that it is used in such an environment.

Immunity test	IEC 60601 Test level	Compliance level	Electromagnetic Environment-Guidance
Electrostatic discharge(ESD) IEC 61000-4-2	± 8 kV contact ± 2 kV, ± 4 kV, ± 8 kV, ± 15 kV air	± 8 kV contact ± 2 kV, ± 4 kV, ± 8 kV, ± 15 kV air	Floors should be wood, concrete or ceramic tile. If floors are covered with synthetic material, the relative humidity should be at least 30%
Power frequency(50, 60 Hz) magnetic field IEC 61000-4-8	<u>30 A/m</u>	30 A/m	The product power frequency magnetic fields should be at levels characteristic of a typical location in a typical commercial or hospital environment.
NOTE UT is the a.c. mains voltage prior to application of the test level.			

Guidance and manufacturer's declaration-electromagnetic immunity

The product is intended for use in the electromagnetic environment specified below.

The customer or the user of the product should assure that is used in such and environment.

Immunity test	IEC 60601 test level	Compliance level	Electromagnetic environment-guidance
Radiated RF IEC 61000 -4-3	3 V/m <u>80MHz to 2,7 GHz</u>	3 V/m <u>80MHz to 2,7 GHz</u>	<p>Recommended separation distance:</p> <p>$d = 1,2 \sqrt{P}$ $d = 1,2 \sqrt{P}$ 80MHz to 800 MHz $d = 2,3 \sqrt{P}$ 800MHz to 2,7GHz</p> <p>Where P is the maximum output power rating of the transmitter in watts (W) according to the transmitter manufacturer and d is the recommended separation distance in metres (m).</p> <p>Field strengths from fixed RF transmitters, as determined by an electromagnetic site survey, ^a should be less than the compliance level in each frequency range.^b</p> <p>Interference may occur in the vicinity of equipment marked with the following symbol:</p> 

NOTE1 At 80 MHz and 800 MHz, the higher frequency range applies.

NOTE2 These guidelines may not apply in all situations. Electromagnetic propagation is affected by absorption and reflection from structures, objects and people.

- a Field strengths from fixed transmitters, such as base stations for radio (cellular/cordless) telephones and land mobile radios, amateur radio, AM and FM radio broadcast and TV broadcast cannot be predicted theoretically with accuracy. To assess the electromagnetic environment due to fixed RF transmitters, an electromagnetic site survey should be considered. If the measured field strength in the location in which the product is used exceeds the applicable RF compliance level above, the product should be observed to verify normal operation. If abnormal performance is observed, additional measures may be necessary, such as re-orienting or relocating the product.
- b Over the frequency range 150 kHz to 80 MHz, field strengths should be less than 3V/m.

Recommended separation distance between portable and mobile RF communications equipment and the product

The device is intended for use in an electromagnetic environment in which radiated RF disturbances are controlled. The customer or the user of the device can help prevent electromagnetic interference by maintaining a minimum distance between portable and mobile RF communications equipment (transmitters) and the device as recommended below, according to the maximum output power of the communications equipment.

Rated maximum output power of transmitter W	Separation distance according to frequency of transmitter m		
	150 kHz to 80 MHz $d = 1,2\sqrt{P}$	80 MHz to 800 MHz $d = 1,2\sqrt{P}$	800 MHz to 2,7 GHz $d = 2,3\sqrt{P}$
0,01	0,12	0,12	0,23
0,1	0,38	0,38	0,73
1	1,2	1,2	2,3
10	3,8	3,8	7,3
100	12	12	23

For transmitters rated at a maximum output power not listed above, the recommended separation distance d in metres (m) can be estimated using the equation applicable to the frequency of the transmitter, where p is the maximum output power rating of the transmitter in watts (W) according to the transmitter manufacturer.

NOTE1 At 80 MHz and 800 MHz, the separation distance for the higher frequency range applies.

NOTE2 These guidelines may not apply in all situations. Electromagnetic propagation is affected by absorption and reflection from structures, objects and people.

II. Installation

A. Safety Warning

Lift Scale must NOT tilt at any time

1. Lift scale must NOT tilt when installed on Patient Lift System.

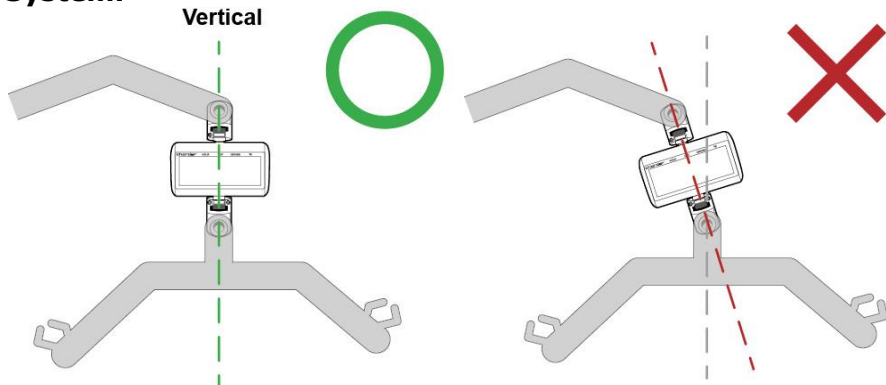

If Lift Scale is tilted and not completely vertical when installed, this will cause the joints of the Lift Scale to bend. This will eventually cause breakage once used enough times and subjected to enough weight, because force is being applied against joints in a way that they aren't designed to handle.

2. Lift Scale must NOT tilt at any time during Patient Lift System's operation.

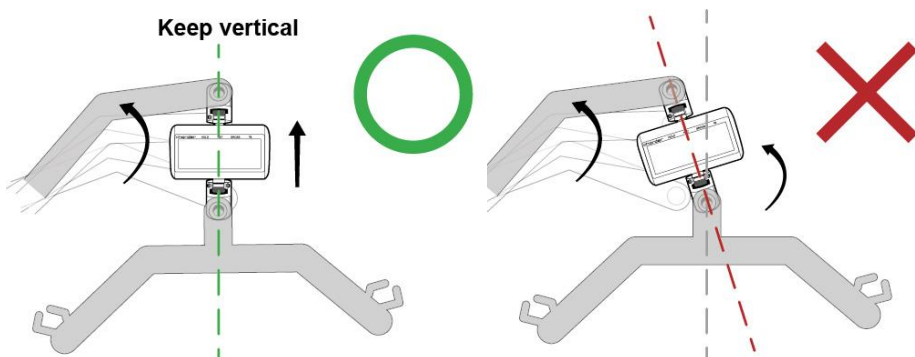

Even if Lift Scale is completely vertical when installed, if it is bent at any point in operation (ex: Patient Lift System raises patient to higher point for weight measurement), the same risk of breakage applies.

IMPORTANT: If tilt or bending is observed at any time, the Lift Scale must NOT be used.

Inspect cardan joints before use for signs of damage or looseness

1. Inspect cardan joints connecting Lift Scale to Patient Lift System visually before use.

The Lift Scale is designed to be installed between the lifting bar and hanger of the Patient Lift System, in a completely vertical position.

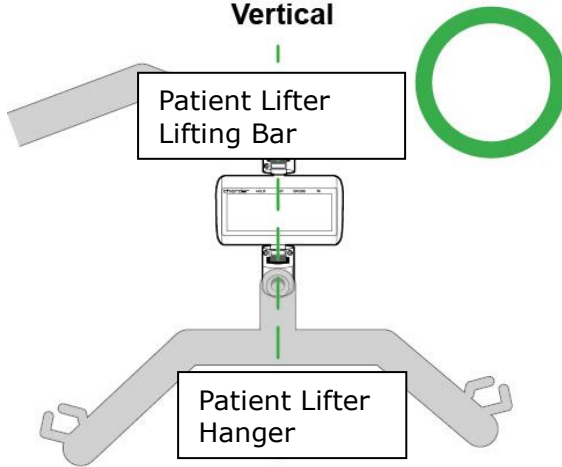

Both top and bottom cardan joints should be inspected for bending.

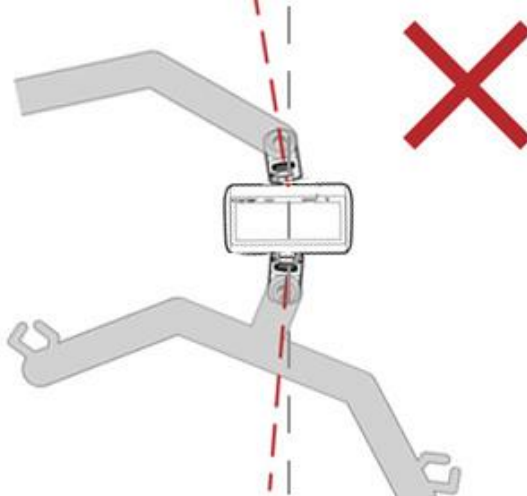

If any visual damage or bending is observed, do NOT use Lift Scale.

2. If no visual damage is observed, the Lift Scale should be twisted manually to test if incorrect movement is possible.

Charder Lift Scales should be installed on Patient Lift Systems utilizing 360-degree swivel bearings. Rotation should be conducted using **Lift System**, rather than device.

The cardan joints on MHS2500I / MHS2600I Lift Scales (with **fixed** cardan joints) do NOT swivel. If they can be manually twisted, that means the joints are damaged, and the Lift Scale should NOT be used.



(MHS2500I / MHS2600I non-rotating cardan joint model)

The cardan joints on MHS2510I / MHS2610I Lift Scales (with **rotating** cardan joints) will swivel, but only **horizontally**. If they can be manually twisted in any other direction, that means joints are damaged, and the Lift Scale should NOT be used Scale.

3. Lift Scale and hanger bar must be allowed free movement in all directions.

If Lift Scale is obstructed from free movement, twisting force will be applied to Lift Scale, potentially causing damage.

Lift Scale should be installed on Patient Lift System that allows 360-degree free swivel

1. Rotation should be conducted by 360-degree free swivel Patient Lift System.



Even if the MHS2510I / MHS2610I Lift Scales with horizontally-rotating cardan joints are used, rotation should be conducted by the Patient Lift System, and not the Lift Scale, to minimize risk of damage to Lift Scale.

Nylock Screws must be screwed in tightly according to specifications

Nylock Screws must be secured according to correct assembling procedure. Prepare one hexagon screwdriver and one torque wrench.

- 1. Hold/fix one side using screwdriver**
 - 2. Tighten/attach Nylock Screws using torque wrench (repeat from other side)**
- IMPORTANT: Torque strength must be set at 18kgf-cm \pm 1kgf-cm**

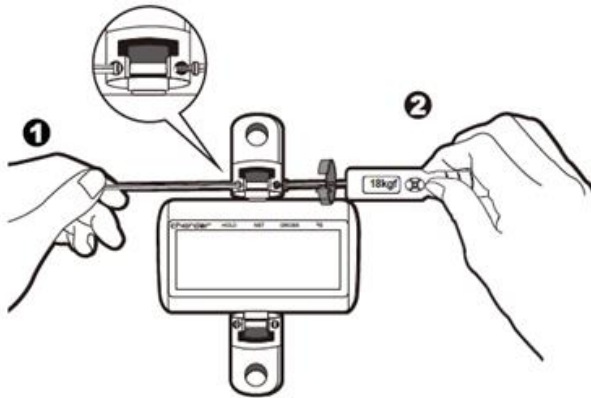

IMPORTANT: Nylock Screw must be secured from both sides (one side with screwdriver, other side by torque wrench). Nylock Screw will not tighten, and will simply rotate in place if counter-force from other side is not applied.

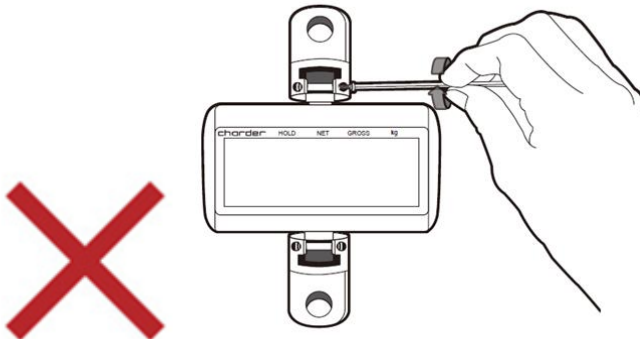

Check to ensure all screws are fully tightened

No.	Item	Qty
A.	Hexagon Nylock screw	2 screws per joint
B.	Stopper screw	1 screw per joint

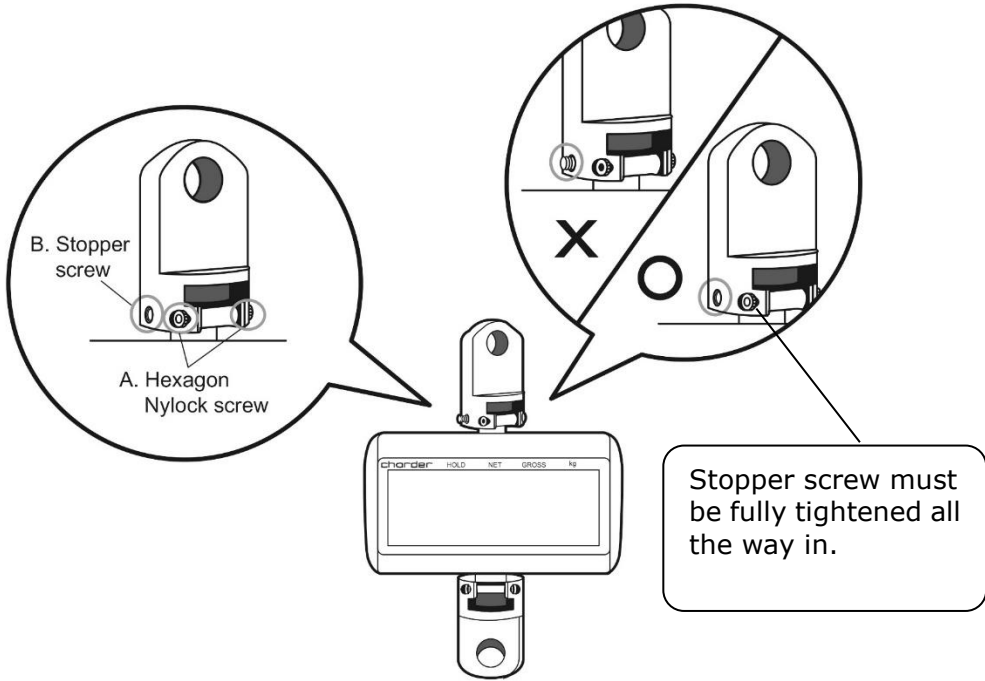

CAUTION: DO NOT use the Lift Scale if any screws are loose.

B. Inserting Batteries

1. Locate battery cover at rear of device
2. Remove battery cover cover

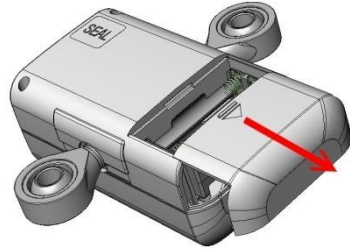
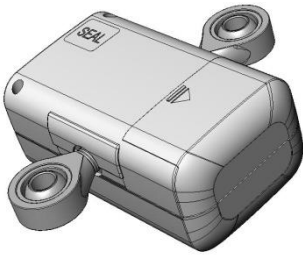

3. Remove battery case

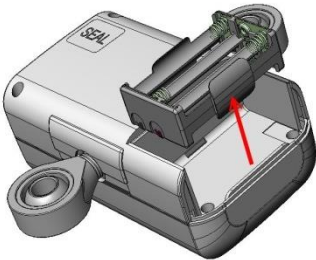

4. Insert batteries

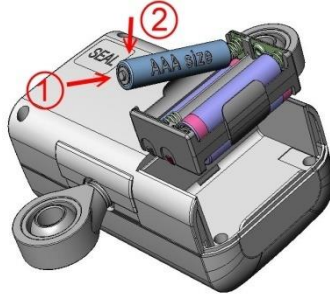

5. Insert battery case

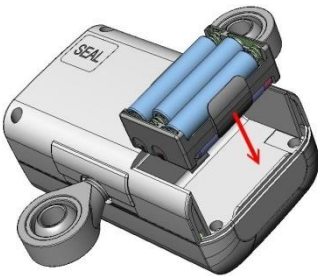

6. Replace battery cover

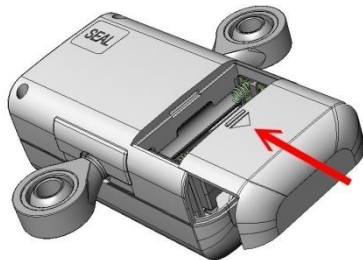

III. Indicator and Key Functions

A. Device indicator (OIML model)

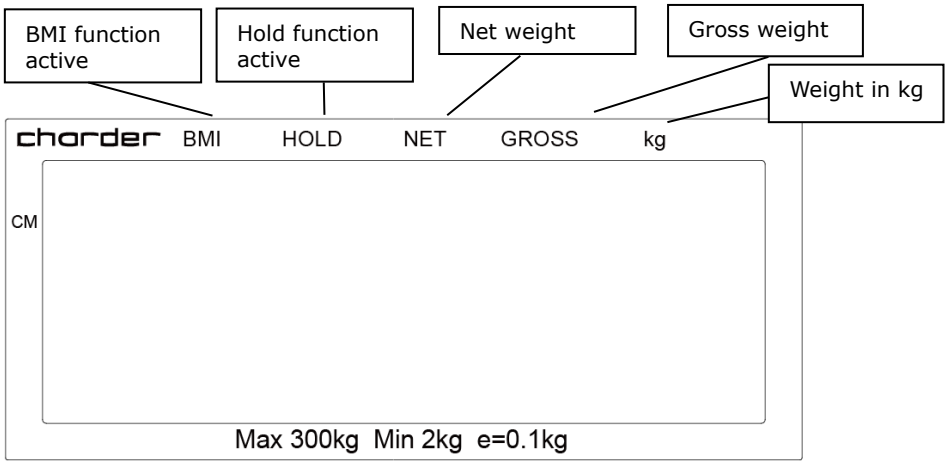

Device indicator (3-key Unit model)

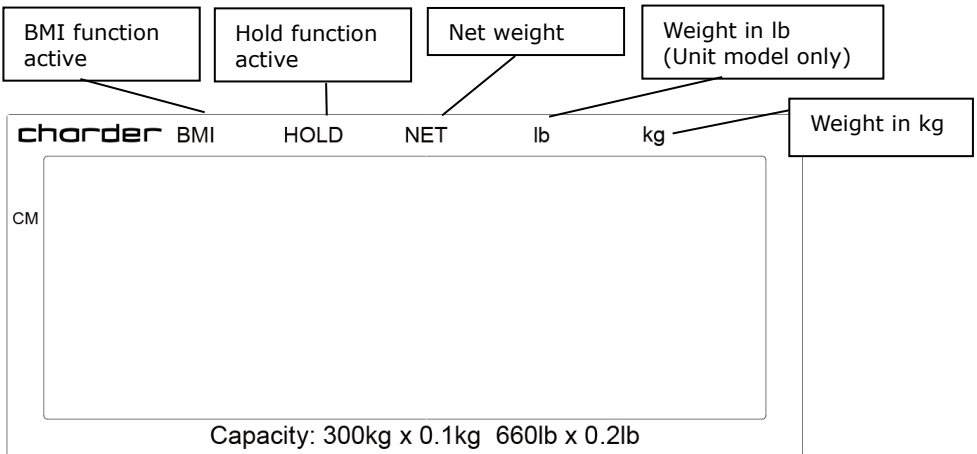



Display

- Stable : Indicate that weight is stable
- Negative weight : Weight under zero
- ← Zero : Weight is at zero

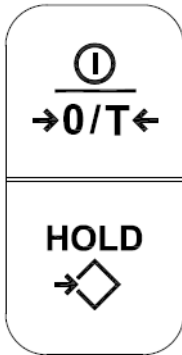
B. Key Function





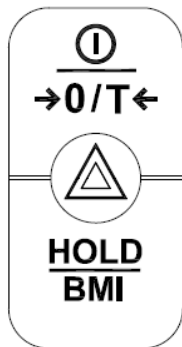

Key Function (2-key model)

1. : Power on or power off. Reset display to 0.0 kg display (can be used if within $\pm 2\%$ of full capacity). Press and hold for 3 seconds to turn off.
2. : Determine stable weighing value - used when weight is unstable. Press and hold for 3 seconds to enter settings.





Key Function (3-key model)

1. : Power on or power off. Reset display to 0.0 kg display (can be used if within $\pm 2\%$ of full capacity). Press and hold for 3 seconds to turn off.
2. : Determine stable weighing value - used when weight is unstable. Press and hold for 3 seconds to enter settings.
3.  : Enter device settings

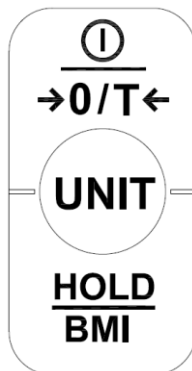
Key Function (3-key unit model)



1. : Power on or power off. Reset display to 0.0 kg display (can be used if within $\pm 2\%$ of full capacity). Press and hold for 3 seconds to turn off.
2. : Determine stable weighing value - used when weight is unstable. Press and hold for 3 seconds to enter BMI mode.
3. : Switch between kg and lb. Last-used unit will be stored in memory. (non-functional on OIML model). Press and hold for 3 seconds to enter device settings

IV. Using Device

A. Basic Operation

Switch on the device using  key. The device will automatically perform self-calibration, displaying software version.

Once "0.00 kg" appears on indicator, device is ready for measurement.

Note: If "0.00 kg" does not display on indicator, press  key to zero the device. This function can be used for weight within $\pm 2\%$ of full capacity.



Guide subject to sit upon sling (or other device connected to lift). After the weight has stabilized, the "stable" symbol will appear on indicator.

Note: If subject's weight exceeds scale capacity (including tare), indicator will display "Err" prompt due to overload.

B. Hold

The hold function determines average weight, designed to be used if subject's weight will not stabilize (ex: an active child).

Note: if fluctuation is too severe, average weight determination will be difficult and hold may not function correctly

1. Switch on the device normally.
2. Press the **[HOLD]** key ( on 3-key model). "HOLD" will be displayed on the indicator.
3. Conduct measurement as usual.
4. After a few seconds, the average weight will be displayed on the indicator. This weight will be locked - at this point, subject movement will not affect weight.
5. To release the locked weight, press the **[HOLD]** key ( on 3-key model) again to return to the device to normal mode.

Note: Hold function can be activated before or after subject stands on measurement platform. However, if subject finds it difficult to stand still, we recommend activating Hold after subject stands on platform.

C. BMI(3–key model)

1. In normal mode, press and hold **HOLD BMI** key to enter BMI mode.
2. Display will show last recorded height. Digits will flash.
3. Press **0/T** key to increase, **[Δ]** to decrease. Press and hold to speed up.
4. After inputting height, press **HOLD BMI** to confirm.
5. Proceed to weigh subject as usual. Indicator will display weight, height, and BMI.

NOTE: Hold function can be used at this time if weight is unstable

6. Press **HOLD BMI** key to return to normal mode.

Category	BMI (kg/m ²)	Risk of obesity-related disease
Under	< 18.5	Low
Normal	18.5-24.9	Average
Over	24.9-29.9	Slightly Increased
Obese I	30.0-34.9	Increased
Obese II	35.0-39.9	High
Obese III	> 40	Very High

(World Health Organization adult BMI standards)

NOTE: though BMI is calculated in the same way, subjects under the age of 18 should use separate standards for interpretation, in comparison with percentile charts for their age group.

D. Tare

The tare function allows the user to deduct the weight of objects from the device's measurement result.

1. Place object that needs to be tared onto sling.
2. Press **0/T** key after stable symbol appears on indicator. Display will indicate "0.00 kg".
3. Guide subject (plus tared object) to be weighed upon sling. Conduct measurement.
4. To clear tare value, remove all objects from measurement platform, and press **0/T** key.

V. DeviceSetup

2-key model

When the device is switched on, press and hold the **[HOLD]** key for about 3 seconds, until the display shows the "SETUP", followed by "A_OFF" (first option in setting menu).

In device setup menu:

[HOLD] to toggle next menu option



to confirm selection / enter submenu

Auto Power-Off:

Instruct device to shut off automatically after a certain period of time.

Auto off options: 120 sec / 180 sec / 240 sec / 300 sec / off

Press **[HOLD]** to toggle between time options, and  to confirm selection.

Buzzer/Beep:

When function is turned on, beeping noise will be made when: indicator is turned on, keys are pressed, and weight is stable.

Press **[HOLD]** to toggle between on/off, and  key to confirm selection.

3-key △ model

When the device is switched on, press and hold the△key for about 3 seconds, until the display shows the "SETUP", followed by"A_OFF" (first option in setting menu).

In device setup menu:



 to toggle next menu option

 to confirm selection / enter submenu

Auto Power-Off:



Instruct device to shut off automatically after a certain period of time.

Auto off options: 120 sec / 180 sec / 240 sec / 300 sec / off

Press  to toggle between time options, and  to confirm selection.

Buzzer/Beep:



When function is turned on, beeping noise will be made when: indicator is turned on, keys are pressed, and weight is stable.

Press  to toggle between on/off, and  key to confirm selection.

3-key Unit model

When the device is switched on, press and hold the  key for about 3 seconds, until the display shows the "SETUP", followed by "A_OFF" (first option in setting menu).



In device setup menu:

- 1 ·  to toggle next menu option
- 2 ·  to confirm selection / enter submenu

Auto Power-Off:



Instruct device to shut off automatically after a certain period of time.

Auto off options: 60 sec / 120 sec / 180 sec / 240 sec / 300 sec / off

Press  to toggle between time options, and  to confirm selection.

Buzzer/Beep:

When function is turned on, beeping noise will be made when: indicator is turned on, keys are pressed, and weight is stable.

Press  to toggle between on/off, and  key to confirm selection.

VI. Troubleshooting

Before contacting your local Charder distributor for repair service, we recommend considering the following troubleshooting procedures:

Self-inspection

1. Device will not power on

- If battery power is depleted, replace with new batteries

2. Indicator showing "00000" ZERO SPAN out of range

- Interference due to factors such as RF disturbance or ground vibration. Relocate device to location without interference and try again
- External objects interfering with device. Clear area of interfering objects and try again
- If the steps above cannot resolve the problem, re-calibration may be required to correct weighing accuracy

Distributor support required

If the following errors occur, we recommend contacting your local Charder distributor for repair or replacement services:

1. Device will not power on

- Faulty on/off key
- Broken or damaged wires causing short circuit or faulty connection
- Safety fuse burnout

2. Indicator damage

- Possible hardware defects include: uneven brightness in LCD screen, blurred text, smeared rainbow screen, incorrect decimal display
- Unable to save or read data
- Indicator shows "ERRL" after device is switched on
- Keys not responding
- Buzzer malfunction

Error Messages

Error Message	Reason	Action
LobAt	Low battery warning Voltage of battery is too low to operate device	Replace batteries
Err	Overload Total load exceeds device's maximum capacity	Reduce weight on measurement platform and try again
Err.L	Counting Error Signal from loadcells too low	Error normally caused by faulty loadcell or wiring. Please contact distributor
00000	Zero count over calibration zero range +10% while power on	Re-calibration required. Please contact distributor
00000	Zero count under calibration zero range -10% while power on	Re-calibration required. Please contact distributor
Err.E	Program Error Fault with device software	Please contact distributor

VII. Product Specifications

A. Device Information

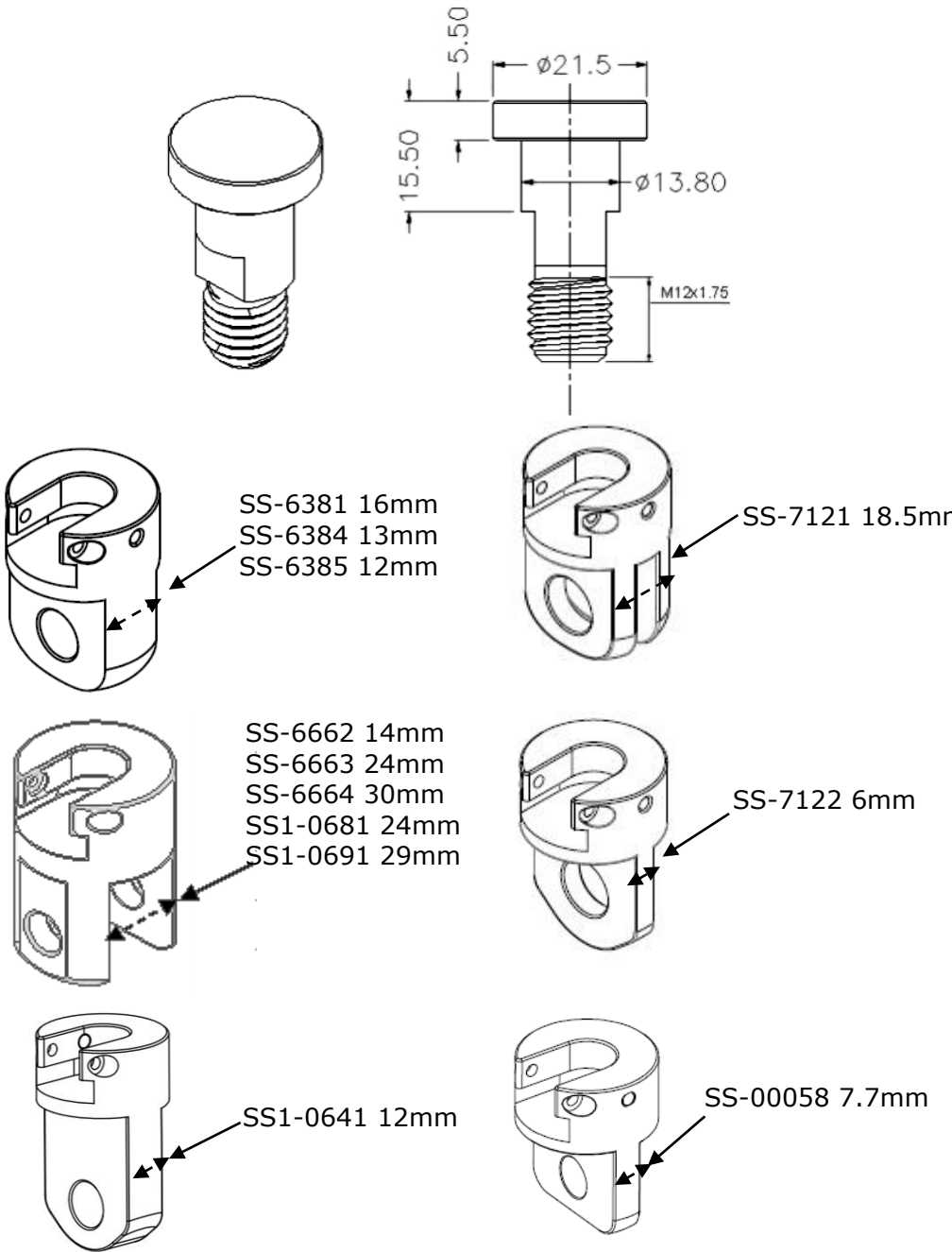

Model		MHS2510I / MHS2610I	
Weight Measurement	Capacity	150/175/200/230 /300 kg x 0.1 kg	400 kg x 0.2 kg
	Accuracy	±1.5e	
	OIML	Class III	
	Unit	kg/lb (non-OIML models only)	
	LCD Screen	1.0-inch LCD screen (5 1/2 digits)	
Dimensions	Overall	122(W) x 52(D) x 180(H) mm	
	Device Weight	1.04 kg	
Key Functions (2-key model)		On/Off/Zero/Tare, Hold	
Key Functions (3-key model)		On/Off/Zero/Tare, Hold/BMI Unit (non-OIML model) △Setup (OIML model)	
Power Supply		6 AAA batteries	
Operation Environment		0°C~+40°C 15% / 85% RH 700 hPa ~1060 hPa	

B. Technical Data for Joints



VIII. Declaration of Conformity

This product has been manufactured in accordance with the harmonized European standards, following the provisions of the below stated directives:

	(EU) 2017/745 Regulation on Medical Devices
	2014/31/EU Non-automatic Weighing Instruments Directive (OIML models only)

RoHS Directive 2011/65/EU and Delegated Directive (EU) 2015/863

Radio Equipment Directive 2014/53/EU

(applicable if wireless module is used)

Part 15 of the Federal Communications Statement Rules

This device may not cause harmful interference.

This device must accept any interference received, including interference that may cause undesired operation.

Please see separate document showing on sticker of device for above markings.

Authorized EU Representative:



Manufactured by:



Charder Electronic Co., Ltd.
No.103, Guozhong Rd., Dali Dist.,
Taichung City 41262 ,Taiwan

CD-IN-1191 11159U 08/2024