



Stand-on Floor Scale

USER MANUAL **MS3450**

















Please keep the instruction manual at hand and follow instruction for use.

CONTENTS

I. Explanation of Graphic Symbols on Label/Packaging	3
II. Copyright Notice	5
I. Safety Notes	6
A. General Information	6
B. EMC Guidance and Manufacturer's Declaration	10
II. Installation	14
A. Assembly	14
B. Inserting Batteries	17
C. Using Adapter	18
D. Attaching Height Rod to Column	19
III. Indicator	20
A. Indicator and Key Functions	20
B. Display layout	21
IV. Using Device	22
A. Basic Operation	22
B. Hold	23
C. Tare	23
D. Body Mass Index (BMI)	24
E. Body Surface Area (BSA)	24
F. Print	24
V. Device Setup	25
VI. Setup USB Connection to PC	27
VII. Wireless Connection	30
VIII. Troubleshooting	31
IX. Product Specifications	34
A. Device Information	34
B. Power Adapter Standards	35
C. Standard Accessories	36
X. Declaration of Conformity	40

I. Explanation of Graphic Symbols on Label/Packaging

Text/Symbol	Meaning
	Caution, consult accompanying documents before use
	Separate collection for waste of electrical and electronic equipment, in accordance with Directive 2002/96/EC. Do not dispose of device with everyday waste
	Name and address of device manufacturer, and year/country of manufacture
	Carefully read user manual before installation and usage, and follow instructions for use.
	Medical electrical device, Type B applied part
	Medical electrical device, Type BF applied part
	Device catalogue number / model number
	Name and address of authorized representative in the European Union
	Device is a medical device. Text indicates device category type
	Manufacturer's batch or lot number for device
	Device's serial number
	Device's Unique Device Identifier
	Verification Scale Interval. Value expressed in units of mass. Used to classification and verification of an instrument.
	Device conforms to (EU) 2017/745 Regulation on Medical Devices. Fourdigit number is identifier for medical device Notified Body

Device complies with EC directives (verified models only)

CE M20 0122

M: Conformity label in compliance with Directive 2014/31/EU for non-automatic weighing instruments

20: Year in which conformity verification was performed and the CE label was applied. (ex: 16=2016)

0122: Identifier for metrology Notified Body



Device is a Class III scale in compliance with Directive 2014/31/EU (verified models only)



Name and address of entity importing device (if applicable)



Name and address of entity responsible for translating Information For Use (if applicable)

CON.

Event counter confirming how many times device has been calibrated (if applicable)



Device conforms to Taiwan National Communications Commission(NCC) approval



Device conforms to U.S. Federal Communications Commission regulations

UK CA M 20 8506

Device complies with UK non-automatic weighing instruments regulations 2016 (verified models only)

M: Conformity label in compliance with Non-automatic Weighing instruments Regulations 2016

20: Year in which conformity verification was performed and the UKCA label was applied. (ex: 20=2020)

8506: Identifier for metrology approved body



Device complies with all UK applicable product legislation



Device's polarity of power.

"In case of differences, icon on device itself takes precedence"

II. Copyright Notice

Copyright Notice

Charder Electronic Co., Ltd.

No.103, Guozhong Rd., Dali Dist., Taichung City 41262 Taiwan

Tel: +886-4-2406 3766

Fax: +886-4-2406 5612

Website: www.chardermedical.com E-mail: info_cec@charder.com.tw

Copyright© Charder Electronic Co., Ltd. All rights reserved.

This user manual is protected by international copyright law. All content is licensed, and usage is subject to written authorization from Charder Electronic Co., Ltd. (hereinafter Charder) Charder is not liable for any damage caused by a failure to adhere to requirements stated in this manual. Charder reserves the right to correct misprints in the manual without prior notice, and modify the exterior of the device for quality purposes without customer consent.



Charder Electronic Co., Ltd.
No. 103, Guozhong Rd., Dali Dist.,
Taichung City, 412 Taiwan

III. Safety Notes

A. General Information

Thank you for choosing this Charder Medical device. It is designed to be easy and straightforward to operate, but if you encounter any problems not addressed in this manual, please contact your local Charder service partner.

Before beginning operation of the device, please read this user manual carefully, and keep it in a safe place for reference. It contains important instructions regarding installation, proper usage, and maintenance.

Intended Purpose

This medical device is designed to be used in accordance with national regulations, to measure weight within specifications, for weight-related usage by professionals.

Clinical Benefit

Measurement results can be used by professionals to diagnose (and monitor) weight-related issues.

Intended medical indications/contraindications

Measurement: patient's body weight. No known contraindications to measurement of body weight.

Intended patient profile

- (a) Age: no restrictions
- (b) Weight: no restrictions within device weight capacity
- (c) Patient Conditions: require measurement of body weight. Able to stand independently without support.

Intended user profile

- (a) At least 20 years old
- (b) Minimum knowledge:
 - To be able to read at a high-school level and understand Arabic numerals (e.g. 1, 2, 3, 4...)
 - Basic hygiene knowledge
 - Trained in device's operation
 - Read the instruction manual

- (c) Language
 - Able to read the language of instruction manual and on-screen instructions
- (d) Qualifications
 - No special certifications or qualifications required

Residual Risk Evaluation

- (a) All foreseeable risks have been evaluated and considered acceptable. Generally speaking, the most likely risk caused by incorrect usage of the device is less accurate measurement (or inability to use device to acquire measurement), which does not pose imminent physical risk to patient or user.
- (b) Benefit-risk ratio is considered acceptable. Stand-on floor scales are an important option for measuring patients. Usage of device is unlikely to result in harm to user or patient.

General Handling

- Device should be placed on stable, flat, solid, non-slippery surface.
- Usage on soft surfaces (ex: carpet) may result in inaccurate results.
- Ensure all parts are properly locked and tightened before operating the device.
- Device is intended to measure one subject at a time.

Safety Instructions

Before putting device into use, please read this user manual carefully. It contains important instructions for installation, usage, and maintenance of device.

The manufacturer shall not be liable for damages caused by failure to heed the following instructions:

- Batteries should be kept away from children. If swallowed, promptly seek medical assistance.
- Expected service life: 5 years.
- Always comply with appropriate regulations when using electrical components under increased safety requirements.
- Improper installation will render the warranty null and void.
- Ensure voltage marked on power supply matches mains power supply.
- The device is intended for indoor use only.
- Observe permissible ambient temperatures for use
- Device meets requirements for electromagnetic compatibility. Do not exceed the maximum values specified in the applicable standards.

Environmental

- All batteries contain toxic compounds; batteries should be disposed of via designated competent organizations. Batteries should not be incinerated.

Cleaning

- Device surface should be cleaned using alcohol-based wipes. Corrosive cleansing liquids should not be used. Pressure-washers should not be used.
- Do not use large amounts of water when cleaning the device, as it may cause damage to the internal electronics.
- Always disconnect device from mains power before cleaning.

Maintenance

- Please contact your local Charder distributor for regular maintenance and calibration, regular checking of accuracy is recommended; frequency to be determined by level of use and state of device.

Warranty/Liability

- If Charder is responsible for a fault or defect present upon receipt of the unit, Charder shall either repair the fault, or supply a replacement unit. Should the repairs or replacement delivery fail, statutory provisions shall be valid. The period of warranty shall be two years, beginning on the date of purchase. Please retain your receipt as proof of purchase.
- No responsibility shall be accepted for damage caused through any of the following reasons: unsuitable or improper storage or use, incorrect installation or commissioning by the owner or third parties, natural wear and tear, changes or modifications, incorrect or negligent handling, chemical, electrochemical, or electrical interference, unless damage is attributable to negligence on the part of Charder.
- This device does not contain any user-maintained parts. All maintenance, technical inspections, and repairs should be conducted by an authorized Charder service partner, using original Charder accessories and spare parts. Charder is not liable for any damages arising from improper maintenance or usage. Dismantlement of the device will void the warranty.

Disposal

- This product is not to be treated as regular household waste, but should be taken to a designated collection points for electronics. Further information should be provided by local waste disposal authorities.



Warning

- Only the original adapter should be used with the device. Using an adapter other than the one provided by Charder may cause malfunction.
- Do not touch the power supply with wet hands.
- Do not crimp the power cable, and avoid sharp edges.
- Do not overload extension cables connected to the device.
- Route cables carefully, to avoid tripping.
- Keep device away from liquids.
- Do not remove the plug by yanking on the cable.
- Use only a correctly wired (100-240VAC) outlet, and do not use a multiple outlet extension cable.
- Do not under any circumstances dismantle or alter the device, as this could result in electric shock or injury as well as adversely affect the precision of measurements.
- Do not place the device in direct sunlight, or in close proximity to an intense heat source. Excessively high temperatures may damage the internal electronics.

Incident Reporting

- Any serious incident that has occurred in relation to the device should be reported to the manufacturer, EU representative (if device is used in EU member state), and competent authority of user/subject's member state.

B. EMC Guidance and Manufacturer's Declaration

Guidance and manufacturer's declaration-electromagnetic emissions		
The product is intended for use in the electromagnetic environment specified below. The customer or the user of the product should assure that it is used in such an environment.		
Emission test	Compliance	Electromagnetic environment-guidance
RF emissions CISPR 11	Group 1	The product uses RF energy only for its internal function. Therefore, its RF emissions are very low and are not likely to cause any interference in nearby electronic equipment.
RF emissions CISPR 11	Class A	The product is suitable for use in all establishments other than domestic and those directly connected to a low voltage power supply network which supplies buildings used for domestic purposes.
Harmonic emissions IEC 61000-3-2	Class A	
Voltage fluctuations /flicker emissions IEC 61000-3-3	Compliance	

Guidance and manufacturer's declaration-electromagnetic immunity

The product is intended for use in the electromagnetic environment specified below. The customer or the user of the product should assure that it is used in such an environment.

Immunity test	IEC 60601 test level	Compliance level	Electromagnetic environment-guidance
Electrostatic discharge(ESD) IEC 61000-4-2	<u>±8 kV contact</u> <u>±2 kV, ±4 kV, ±8 kV, ±15 kV air</u>	<u>±8 kV contact</u> <u>±2 kV, ±4 kV, ±8 kV, ±15 kV air</u>	Floors should be wood, concrete or ceramic tile. If floors are covered with synthetic material, the relative humidity should be at least 30%
Electrical fast transient/burst IEC 61000-4-4	<u>± 2kV for power supply lines</u>	<u>± 2kV for power supply lines</u>	Mains power quality should be that of a typical commercial or hospital environment.
Surge IEC 61000-4-5	<u>± 1kV line(s) to line(s)</u> <u>± 2kV line(s) to earth</u>	<u>± 1kV line(s) to line(s)</u> <u>± 2kV line(s) to earth</u>	Mains power quality should be that of a typical commercial or hospital environment.
Voltage Dips, short interruptions and voltage variations on power supply input lines IEC 61000-4-11	<u>0% UT for 0.5 cycle</u> <u>0% UT for 1 cycle</u> <u>70% UT(30% dip in UT) for 25cycles</u> <u>0% UT for 5 s</u>	<u>0% UT for 0.5 cycle</u> <u>0% UT for 1 cycle</u> <u>70% UT(30% dip in UT) for 25cycles</u> <u>0% UT for 5 s</u>	Mains power quality should be that of a typical commercial or hospital environment. If the user of the product requires continued operation during power mains interruptions, it is recommended that the product be powered from an uninterruptible power supply or a battery.
Power frequency(50, 60 Hz) magnetic field IEC 61000-4-8	<u>30 A/m</u>	30 A/m	The product power frequency magnetic fields should be at levels characteristic of a typical location in a typical commercial or hospital environment.

NOTE UT is the a.c. mains voltage prior to application of the test level.

Guidance and manufacturer's declaration-electromagnetic immunity

The product is intended for use in the electromagnetic environment specified below.

The customer or the user of the product should assure that it is used in such an environment.

Immunity test	IEC 60601 test level	Compliance level	Electromagnetic environment-guidance
----------------------	-----------------------------	-------------------------	---

<p>Conducted RF IEC 61000-4-6</p> <p>Radiated RF IEC 61000-4-3</p>	<p>3 Vrms 150 KHz to 80 MHz</p> <p><u>6 V in ISM bands between 0,15 MHz and 80 MHz</u> <u>80 % AM at 1 kHz</u></p> <p>3 V/m <u>80MHz to 2,7 GHz</u></p>	<p>3 Vrms 150 KHz to 80 MHz</p> <p><u>6 V in ISM bands between 0,15 MHz and 80 MHz</u> <u>80 % AM at 1 kHz</u></p> <p>3 V/m <u>80MHz to 2,7 GHz</u></p>	<p>Portable and mobile RF communications equipment should be used no closer to any part of the product including cables, than the recommended separation distance calculated from the equation applicable to the frequency of the transmitter.</p> <p>Recommended separation distance: $d = 1,2 \sqrt{P}$ $d = 1,2 \sqrt{P}$ 80MHz to 800 MHz $d = 2,3 \sqrt{P}$ 800MHz to 2,7GHz Where P is the maximum output power rating of the transmitter in watts (W) according to the transmitter manufacturer and d is the recommended separation distance in metres (m).</p> <p>Field strengths from fixed RF transmitters, as determined by an electromagnetic site survey, ^a should be less than the compliance level in each frequency range.^b</p> <p>Interference may occur in the vicinity of equipment marked with the following symbol:</p> 
<p>NOTE1 At 80 MHz and 800 MHz, the higher frequency range applies.</p> <p>NOTE2 These guidelines may not apply in all situations. Electromagnetic propagation is affected by absorption and reflection from structures, objects and people.</p>			
<p>a Field strengths from fixed transmitters, such as base stations for radio (cellular/cordless) telephones and land mobile radios, amateur radio, AM and FM radio broadcast and TV broadcast cannot be predicted theoretically with accuracy. To assess the electromagnetic environment due to fixed RF transmitters, an electromagnetic site survey should be considered. If the measured field strength in the location in which the product is used exceeds the applicable RF compliance level above, the product should be observed to verify normal operation. If abnormal performance is observed, additional measures may be necessary, such as re-orienting or relocating the product.</p> <p>b Over the frequency range 150 kHz to 80 MHz, field strengths should be less than 3V/m.</p>			

Recommended separation distance between portable and mobile RF communications equipment and the product

The product is intended for use in an electromagnetic environment in which radiated RF disturbances are controlled. The customer or the user of the product can help prevent electromagnetic interference by maintaining a minimum distance between portable and mobile RF communications equipment (transmitters) and the product as recommended below, according to the maximum output power of the communications equipment.

Rated maximum output power of transmitter P (W)	Separation distance according to frequency of transmitter f		
	150 kHz to 80 MHz $d = 1,2\sqrt{P}$	80 MHz to 800 MHz $d = 1,2\sqrt{P}$	<u>800 MHz to 2,7 GHz</u> $d = 2,3\sqrt{P}$
0,01	0,12	0,12	0,23
0,1	0,38	0,38	0,73
1	1,2	1,2	2,3
10	3,8	3,8	7,3
100	12	12	23

For transmitters rated at a maximum output power not listed above, the recommended separation distance d in metres (m) can be estimated using the equation applicable to the frequency of the transmitter, where P is the maximum output power rating of the transmitter in watts (W) according to the transmitter manufacturer.

NOTE1 At 80 MHz and 800 MHz, the separation distance for the higher frequency range applies.

NOTE2 These guidelines may not apply in all situations. Electromagnetic propagation is affected by absorption and reflection from structures, objects and people.

IV. Installation

A. Assembly

1. Insert column into column seat

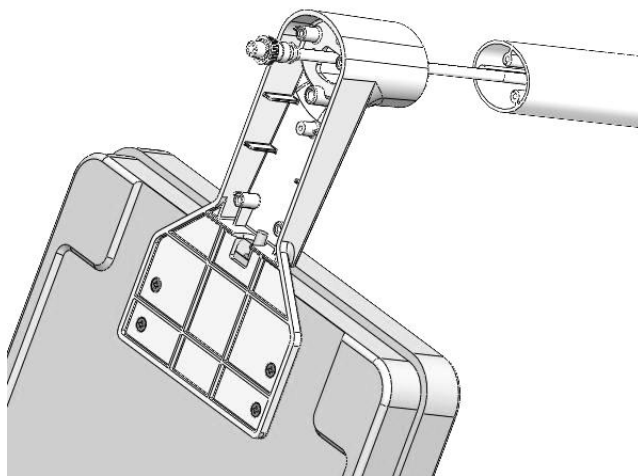

2. Secure column using three M4*0.7*15 screws

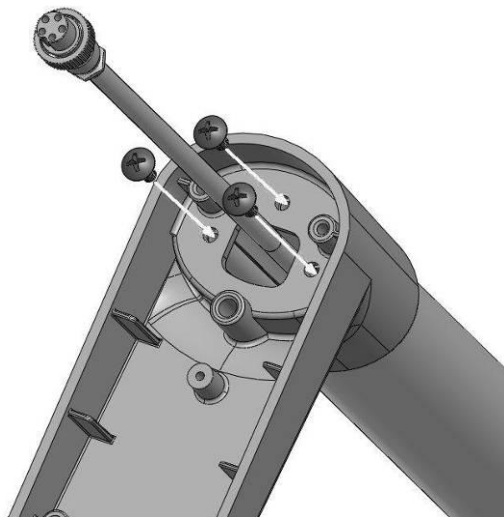

3. Route cable along gap in the column seat

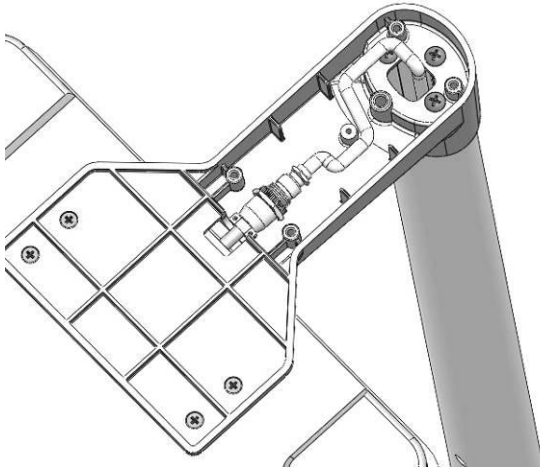

4. Attach bottom cover and secure using four M4*0.7*8 screws

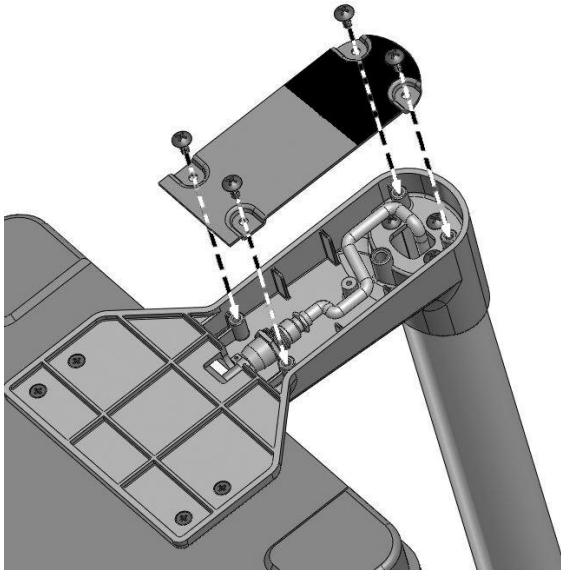

5. Assembly complete

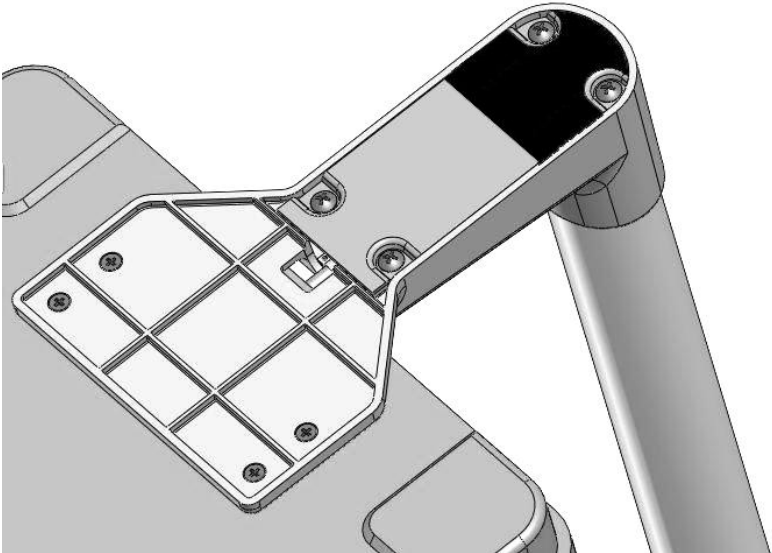

B. Inserting Batteries

1. Open battery housing cover



2. Take out battery housing



3. Place batteries in compartment(ensure polarity is correct)

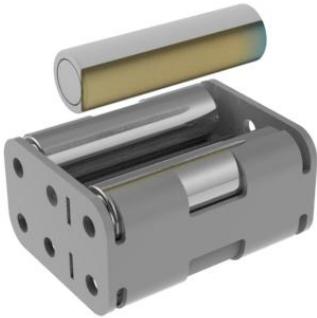

4. Insert battery housing



5. Close battery housing cover.



6. Turn on power to confirm that battery is correctly installed.

C. Using Adapter

1. Connect adapter to indicator before connecting to mains power supply
2. Disconnect adapter from mains power supply before unplugging adapter pin from indicator.

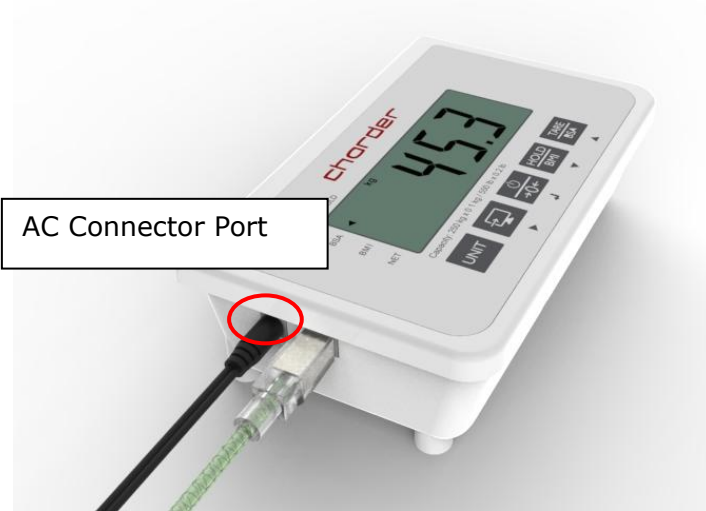

D. Attaching Height Rod to Column

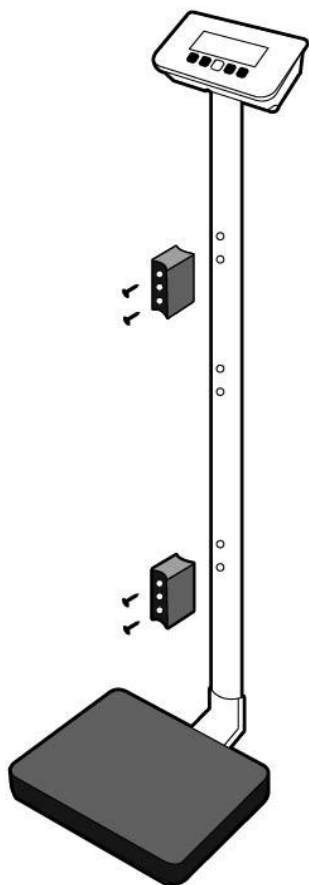

1. Attach two fixing blocks to column using four flat-head screws

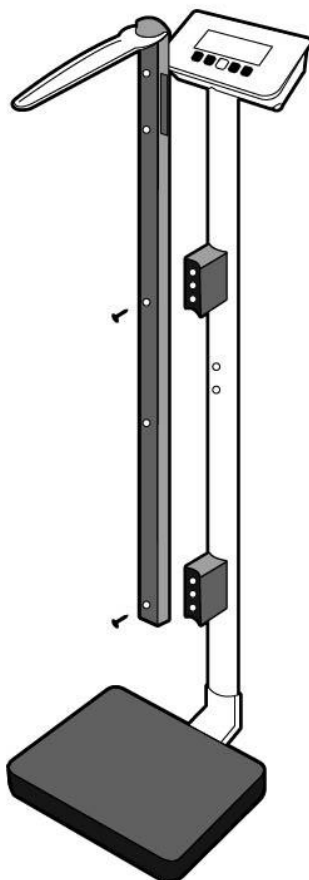

2. Attach height rod to blocks using two flat-head screws

Item	Name	Quantity
1	Fixing block screws	4
2	Fixing blocks	2
3	Height Rod to fixing block screws	2



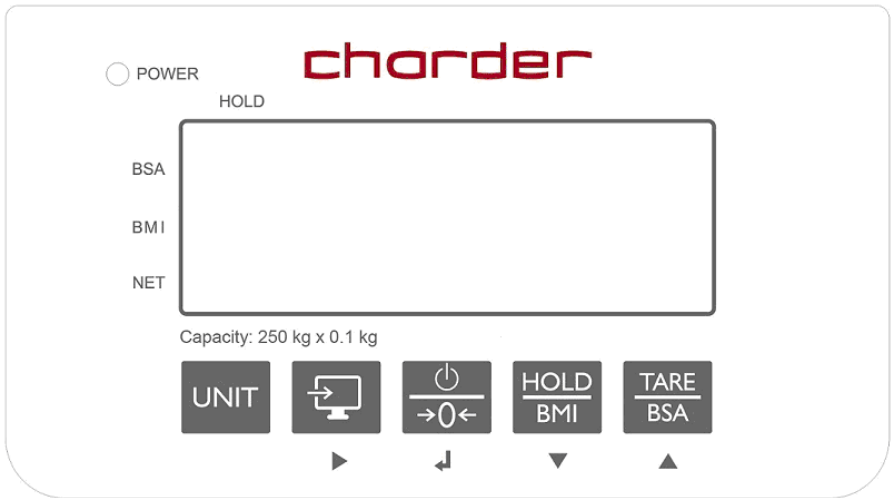

* Photo of display for reference only. Please refer to the actual product.

V. Indicator

A. Indicator and Key Functions



Key Function

-  (UNIT): Switch between units.
-  (Send Data): When printer is connected to the indicator, press this key to send results.
-  (On/Off/Zero): Power button. Press and hold to turn off. Press once to zero weight.
-  (HOLD/BMI): Press once to Hold (determine stable weighing value - used when weight is unstable). Press and hold for 3 seconds to enter Body Mass Index (BMI) calculation mode.
-  (TARE/BSA): Press once to Tare (deduct weight from reading after measurement). After using BMI function, press once to display Body Surface Area (BSA). Press and hold for 6 seconds to enter device settings.

B. Display layout

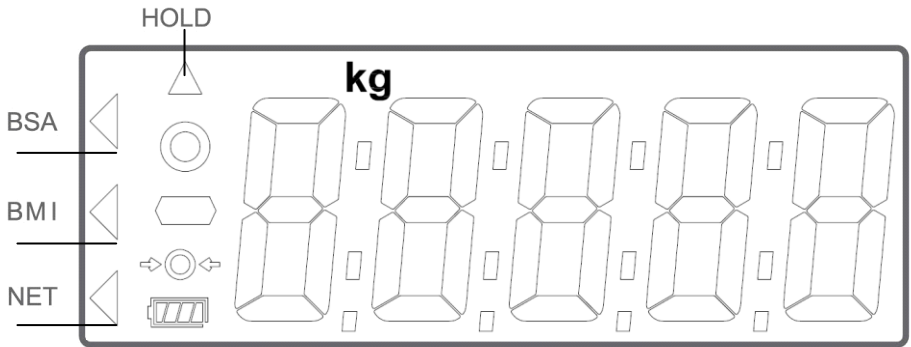

BSA: Body Surface Area is being displayed

BMI: Body Mass Index is being displayed

NET: Net weight appears after tare is activated

HOLD: Weight lock function is in use

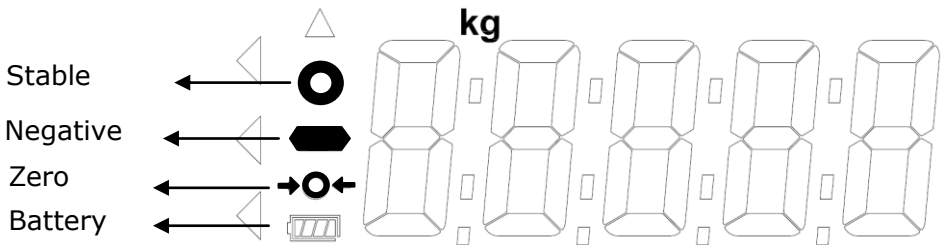

Stable symbol: Indicates that weight is stable.

Negativesymbol: Weight under zero.

Zero symbol: Weight is at zero

Low battery: Battery needs to be charged or replaced.

VI. Using Device



Unit



Send



On/Off/Zero





Hold/BMI



Tare/BSA

A. Basic Operation

Switch on the device using  key. (To turn off device, press and hold  key for 3 seconds) The device will automatically perform self-calibration, displaying software version.

Once "0.00 kg" appears on indicator, device is ready for measurement.

Note: If "0.00 kg" does not display on indicator, press  key to zero the device. This function can be used for weight within $\pm 2\%$ of full capacity.



Guide subject to stand on device. After the weight has stabilized, the "stable" symbol will appear on indicator.

Note: If subject's weight exceeds scale capacity (including tare), indicator will display "Err" prompt due to overload.

B. Hold

The hold function determines average weight, designed to be used if subject's weight will not stabilize (ex: an active child).



Note: if fluctuation is too severe, average weight determination will be difficult and hold may not function correctly

1. Switch on the device normally.
2. Press the  key. "HOLD" will be displayed on the indicator.
3. Guide subject to stand on device.
4. After a few seconds, the average weight will be displayed on the indicator. This weight will be locked - at this point, subject can leave measurement platform.
5. To release the locked weight, press the  key again to return to the device to normal mode.





Note: Hold function can be activated before or after subject stands on device. However, if subject finds it difficult to stand still, we recommend activating Hold after subject stands on device. Hold function will not function under 2 kg.

C. Tare

The tare function allows the user to deduct the weight of objects from the device's measurement result.

1. Place object that needs to be tared onto measurement platform.
2. Press  key after stable symbol appears on indicator. Display will indicate "0.00 kg".
3. Guide subject (plus tared object) to stand on device. Conduct measurement.
4. To clear tare value, remove all objects from measurement platform, and press  key.

D. Body Mass Index (BMI)

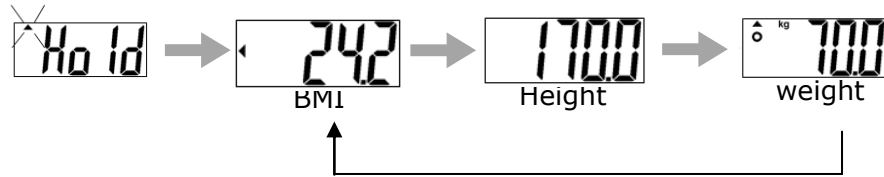

1. In normal mode, press and hold the  key to enter BMI mode.
2. Display will show last input height. Left-most digit will flash.
3. Adjust height value using  (increase ↑) and  (decrease ↓) keys. Proceed to next digit using  key. Press  key to confirm.
5. Proceed to weigh subject as usual. Indicator will display weight, height, and BMI after measurement.



Category	BMI (kg/m ²)	Risk of obesity-related disease
Under	< 18.5	Low
Normal	18.5-24.9	Average
Over	24.9-29.9	Slightly Increased
Obese I	30.0-34.9	Increased
Obese II	35.0-39.9	High
Obese III	> 40	Very High

(World Health Organization adult BMI standards)

E. Body Surface Area (BSA)

1. After calculating BMI, press  key. BSA will be displayed on indicator. Press  key to return to BMI mode. Press  key to return to normal weighing mode.

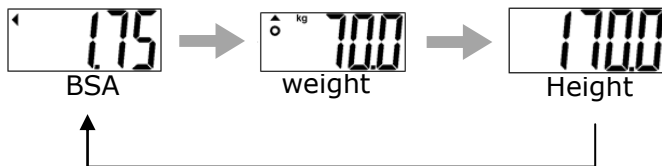

F. Print

If thermal printer is connected to indicator, results can be printed by pressing  key.

VII. Device Setup

When the device is switched on, press and hold the  key for 6 seconds, until the display shows the "SETUP", followed by "AOFF" (first option in setting menu).

In device setup menu:

 to toggle next menu option



 to toggle previous menu option

 to confirm selection



Auto Power-Off: Instruct device to shut off automatically after a certain period of time.



Auto off options: 120 sec / 180 sec / 240 sec / 300 sec / off

Press  to toggle between time options, and  to confirm selection.





Buzzer/Beep:

When function is turned on, beeping noise will be made when: indicator is turned on, keys are pressed, and weight is stable.

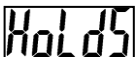
Press  to toggle between on/off, and  key to confirm selection.





Hold Stop: When Hold Stop is "on", Hold will deactivate after subject leaves measurement platform.

Press  to toggle between on/off, and  key to confirm selection



Bluetooth

Bluetooth (optional): If device has Bluetooth module installed, Bluetooth function can be turned on or off.

Press  to toggle between on/off, and  to confirm selection.



Wi-Fi

Wi-Fi (optional): If device has Wi-Fi module installed, Wi-Fi function can be turned on or off.



Press  to toggle between on/off, and  to confirm selection.

Wi-Fi Setting

Wi-Fi Setting (optional): If device has Wi-Fi module installed, this option will appear.

Press  to toggle between "Auto" and "PKEY". Press  to confirm selection.

If "Auto" is selected, weight measurement will be automatically sent to connected printer or device. If "PKEY" is selected, transfer will occur manually only after  key is pressed.

Press  key when  appears on indicator to save all settings and return to weighing mode.

VIII. Setup USB Connection to PC

For successful connection, PC hardware connected to device must be compatible with USB 2.0 or above. Operators should select a USB cable length that is most suitable to the operating environment.

1. Charder Smart Data Manager can be used to connect the device to a PC. The software program can be downloaded from the Charder website:

[LINK URL]<https://www.chardermedical.com/download.htm>

2. Connect USB cable to device indicator and PC. Follow installation instructions.

Program Setup

1. After installation of Charder Smart Data Manager is complete, software will automatically search for COM port. Press **[Connect]**. Once connected, **[Connect]** button will change to **[Disconnect]**.

Ochorder Smart Data Manager COM [v] Connect

Gross Weight	0.0	kg	First Name	Enter
Tare Weight	0.0	kg	Last Name	Enter
Net Weight	0.0	kg	Patient ID	Enter
Height	0.0	cm	Date of Birth	31 / 12 / 1990
BMI	0.0		Gender	Male Female
Data	Auto	Manual		

Please press "Connect".
Update Time:
Model:

Collect Clear Save as

Icons: Globe, Email, Printer, Help

Conducting Measurement

1. Input subject's first name, last name, patient ID, date of birth (DD/MM/YYYY), gender, and height (for BMI calculation) into software if needed. Press **[Clear]** to clear all input.

NOTE: information can also be input after weight measurement.

The screenshot shows the 'chorder Smart Data Manager' interface. On the left, there are input fields for 'Gross Weight' (0.0 kg), 'Tare Weight' (0.0 kg), 'Net Weight' (0.0 kg), 'Height' (167.0 cm), and 'BMI' (0.0). Below these is a 'Data' section with 'Auto' and 'Manual' buttons. On the right, there are input fields for 'First Name' (Jane), 'Last Name' (Doe), 'Patient ID' (20190201), 'Date of Birth' (31 / 12 / 1965), and 'Gender' (Male/Female). At the bottom, there are 'Collect', 'Clear', and 'Save as' buttons. A status bar at the bottom left says 'Please press "Connect". Update Time: Model:'. A 'Connect' button is visible in the top right.

2. Conduct measurement. If **[Auto]** is selected, results will be transmitted from device to software automatically and displayed on the left of screen. If **[Manual]** is selected, user must press "Collect".

The screenshot shows the 'chorder Smart Data Manager' interface after a measurement. The 'Gross Weight' (72.5 kg), 'Tare Weight' (0.0 kg), 'Net Weight' (72.5 kg), 'Height' (167.0 cm), and 'BMI' (26.0) fields are now populated. The 'Data' section shows 'Auto' selected. The patient information fields on the right remain the same. At the bottom left, a status bar shows 'Data updated. Update Time: 06/03/2020 11:40:05 Model:'. The 'Connect' button has changed to 'Disconnect'.

Saving & Printing Results

1. Press **[Save as]** to save measurement results as .csv file on PC. Default file name is same as user ID. (ex: 20190201.csv) To track changes and multiple measurements for the same subject, we recommend not changing the default file name.

Chorder Smart Data Manager COM 5 - Disconnect

Gross Weight 72.5 kg First Name Jane

Tare Weight 0.0 kg Last Name Doe

Net Weight 72.5 kg Patient ID 20190201

Height 167.0 cm Date of Birth 31 / 12 / 1965

BMI 26.0 Gender Male Female

Data Auto Manual

Data updated.
Update Time: 06/03/2020 11:40:05
Model:

Collect Clear Save as

2. Result example:

	A	B	C	D	E	F	G	H	I	J
1	Patient ID	First Name	Last Name	Date of Birth	Gender	Gross Weight	Tare Weight	Net Weight	Height	BMI
2	20190201	Jane	Doe	31/12/1965	Male	72.4 kg	0.0 kg	72.4 kg	167.0 cm	26
3										
4										
5										

If previous results were saved in "20190201.csv", new results also need to be saved as "20190201.csv" (overwriting old file) in order to save multiple results for the same subject.

	A	B	C	D	E	F	G	H	I	J
1	Patient ID	First Name	Last Name	Date of Birth	Gender	Gross Weight	Tare Weight	Net Weight	Height	BMI
2	20190201	Jane	Doe	31/12/1965	Male	72.4 kg	0.0 kg	72.4 kg	167.0 cm	26
3	20190201	Jane	Doe	31/12/1965	Male	75.2 kg	0.0 kg	75.2 kg	167.0 cm	27
4										

Results will be saved in chronological order of measurement.

3. Press the printer icon to print out result using a printer connected to the PC.

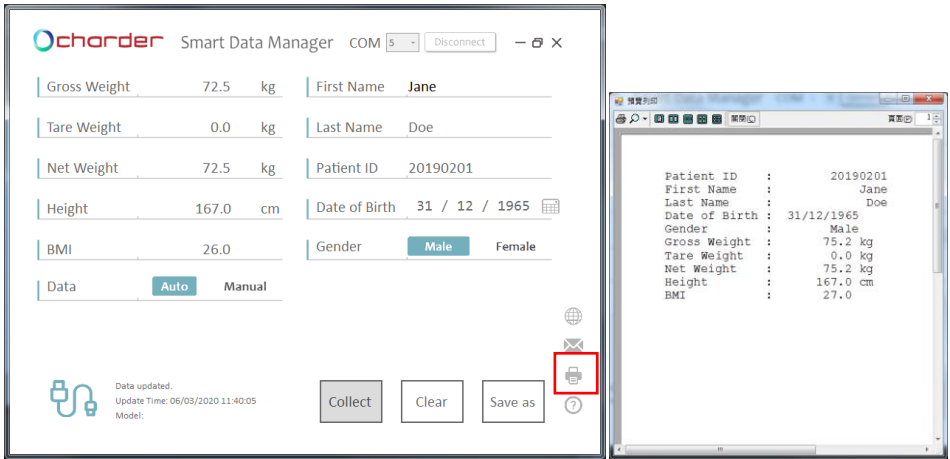

NOTE: Body Surface Area (BSA) data cannot be transferred to PC. BSA results should be read from device indicator.

IX. Wireless Connection

If the device has the wireless or bluetooth module installed, the indicator can transmit measurement results wirelessly. Please see Charder wireless or bluetooth software instructions for details.

X. Troubleshooting

Product Defects

Charder's warranty is effective for the original purchaser of this device, subject to the terms and conditions listed in the Warranty Program & Return Policy.

1. If Charder is responsible for a fault or defect present upon receipt of the unit, Charder shall either repair the fault, or supply a replacement unit. Should the repairs or replacement delivery fail, statutory provisions shall be valid. The period of warranty shall be two years, beginning on the date of purchase. Please retain your receipt as proof of purchase.
2. No responsibility shall be accepted for damage caused through any of the following reasons: unsuitable or improper storage or use, incorrect installation or commissioning by the owner or third parties, natural wear and tear, changes or modifications, incorrect or negligent handling, chemical, electrochemical, or electrical interference, unless damage is attributable to negligence on the part of Charder.

If device is not covered under warranty, a service maintenance charge will apply, plus cost of replacement parts.

Before contacting your local Charder distributor for repair service, we recommend considering the following troubleshooting procedures:

Self-inspection

1. Device will not power on

- If battery power is depleted, replace with new batteries
- If batteries are not used, check if the power adapter is plugged into the device properly. Check if power adapter is plugged into mains properly

2. Indicator showing "0000" ZERO SPAN out of range

- Interference due to factors such as RF disturbance or ground vibration. Relocate device to location without interference and try again
- Unstable platform feet - adjust platform feet according to bubble level indication (clockwise to retract, counter-clockwise to extend) and try again
- External objects interfering with measurement platform. Clear platform of objects and try again

- Device may not function properly on soft surfaces such as carpets or lawns. Relocate device to location with solid, stable floor
- If the steps above cannot resolve the problem, re-calibration may be required to correct weighing accuracy

3. Connection failure for data transmission to PC or printer

- Ensure wires are connected correctly between indicator and PC or printer
- Ensure printer is supplied with power. Ensure PC software is set up properly as indicated in this manual

Distributor support required

If the following errors occur, we recommend contacting your local Charde distributor for repair or replacement services:









1. Device will not power on

- Faulty on/off key
- Broken or damaged wires causing short circuit or faulty connection
- Safety fuse burnout
- Faulty adapter

2. Indicator damage

- Possible hardware defects include: uneven brightness in LCD screen, blurred text, smeared rainbow screen, incorrect decimal display
- Unable to save or read data
- Indicator shows "ERRL" after device is switched on
- Keys not responding
- Buzzer malfunction

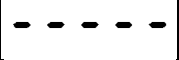
Error Messages

Error Message	Reason	Action
	Low battery warning Voltage of battery is too low to operate device	Replace batteries, or plug in adapter
	Overload Total load exceeds device's maximum capacity	Reduce weight on measurement platform and try again
	Counting Error Signal from loadcells too high or low	Error normally caused by faulty loadcell or wiring. Please contact distributor
	Zero count over calibration zero range +10% while power on	Remove weight from device and try again. If error persists, please contact distributor
	Zero count under calibration zero range -10% while power on	Remove weight from device and try again. If error persists, please contact distributor
	Program Error Fault with device software	Please contact distributor
	Negative weight Weight reading below -2 kg.	Press  key to return to 0.0.

XI. Product Specifications

A. Device Information

Model		MS3450
Display		DP4400
Weight Measurement	Capacity	300kg x 0.1kg
	Accuracy	±1.5e
	Unit	kg / lb
	LCD Screen	1.4-inch LCD screen (5 digits)
Dimensions	Overall	310(W) x 460(D) x 1050(H) mm
	Platform	310(W) x 310(D) x 60(H) mm
	Column	900 mm
	Device Weight	5.3 kg
Key Functions		Unit, On/Off/Zero, Send Data, Hold/BMI, Tare/BSA
Data Transmission		USB NOTE: Device should be connected to network by qualified distributors only.
Power Supply		6 AA batteries /Power adapter
Operation Environment		+5°C~+35°C 15% / 85% RH 700 hPa ~1060 hPa
Optional Accessories		Thermal Printer, Height Meter
Standard Accessories		User manual x1, Power Adapter x1

B. Power Adapter Standards







Warning

The device is only compatible with the power adapters specified in the dashed block below.

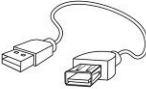

AMP VOLTAGE	DRAWING NO.	CE APPROVED TYPE NO. / MODEL NO.	TYPE	Adapter plug
12V 1A	CD-AD-00043	UES12LCP-120100SPA	US	 180 - degree
	CD-AD-00043	UES12LCP-120100SPA	EU	
	CD-AD-00043	UES12LCP-120100SPA	UK	
	CD-AD-00043	UES12LCP-120100SPA	AU	

C Standard Accessories

No.	Accessories	Item	Spec	Qty
1		M4 Screw	M4*0.7*15	3
2		M4 Screw	M4*0.7*8	4
3		Bottom Cover	/	1
4		USB cable	/	1
5		12V adaptor	ACadaptor	1
6		User manual	IN-00011	1

XII. Declaration of Conformity

This product has been manufactured in accordance with the harmonized European standards, following the provisions of the below stated directives:

	(EU) 2017/745 Regulation on Medical Devices
	2014/31/EU Non-automatic Weighing Instruments Directive (OIML models only)

RoHS Directive 2011/65/EU and Delegated Directive (EU) 2015/863

Radio Equipment Directive 2014/53/EU

(applicable if wireless module is used)

Part 15 of the Federal Communications Statement Rules

This device may not cause harmful interference.

This device must accept any interference received, including interference that may cause undesired operation.

Please see separate document showing on sticker of device for above markings.

Authorized EU Representative:



Obelis s.a.

Bd Général Wahis, 53
B-1030 Brussels
Belgium

Manufactured by:



Charder Electronic Co., Ltd.
No.103, Guozhong Rd., Dali Dist.,
Taichung City 41262 ,Taiwan

CD-IN-00011 REV008 08/2024